

RS232 / RS485

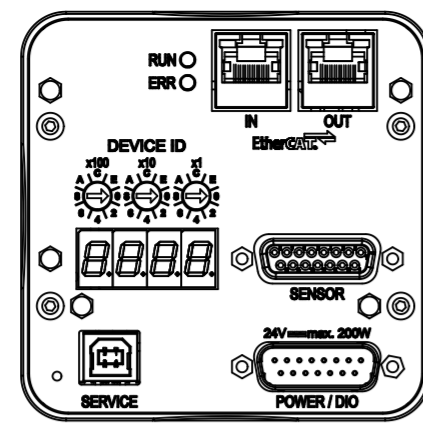

Ether CAT

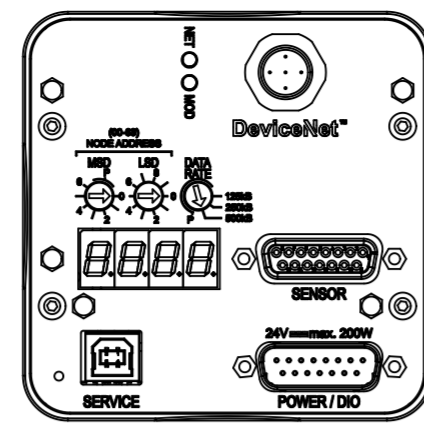

Device Net

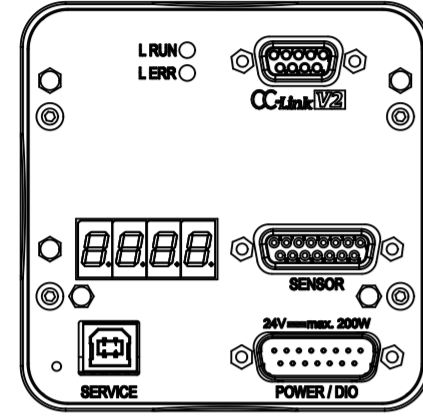

CC-Link

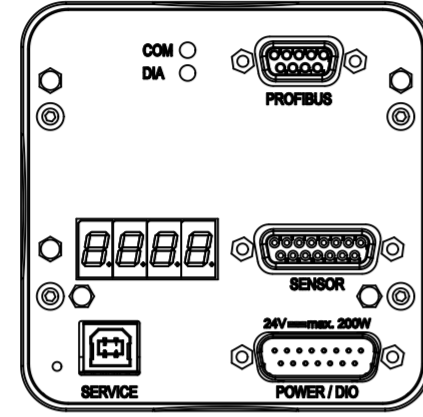

Profibus

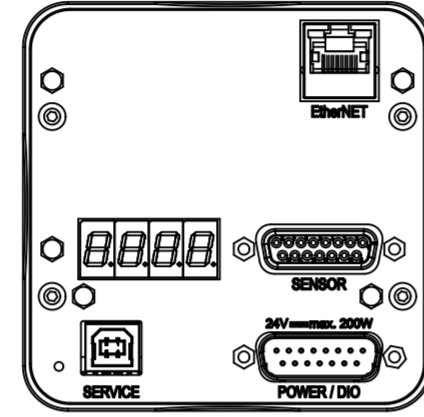

Ether NET

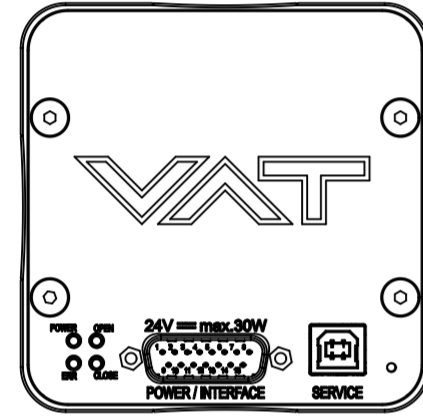

Position Only

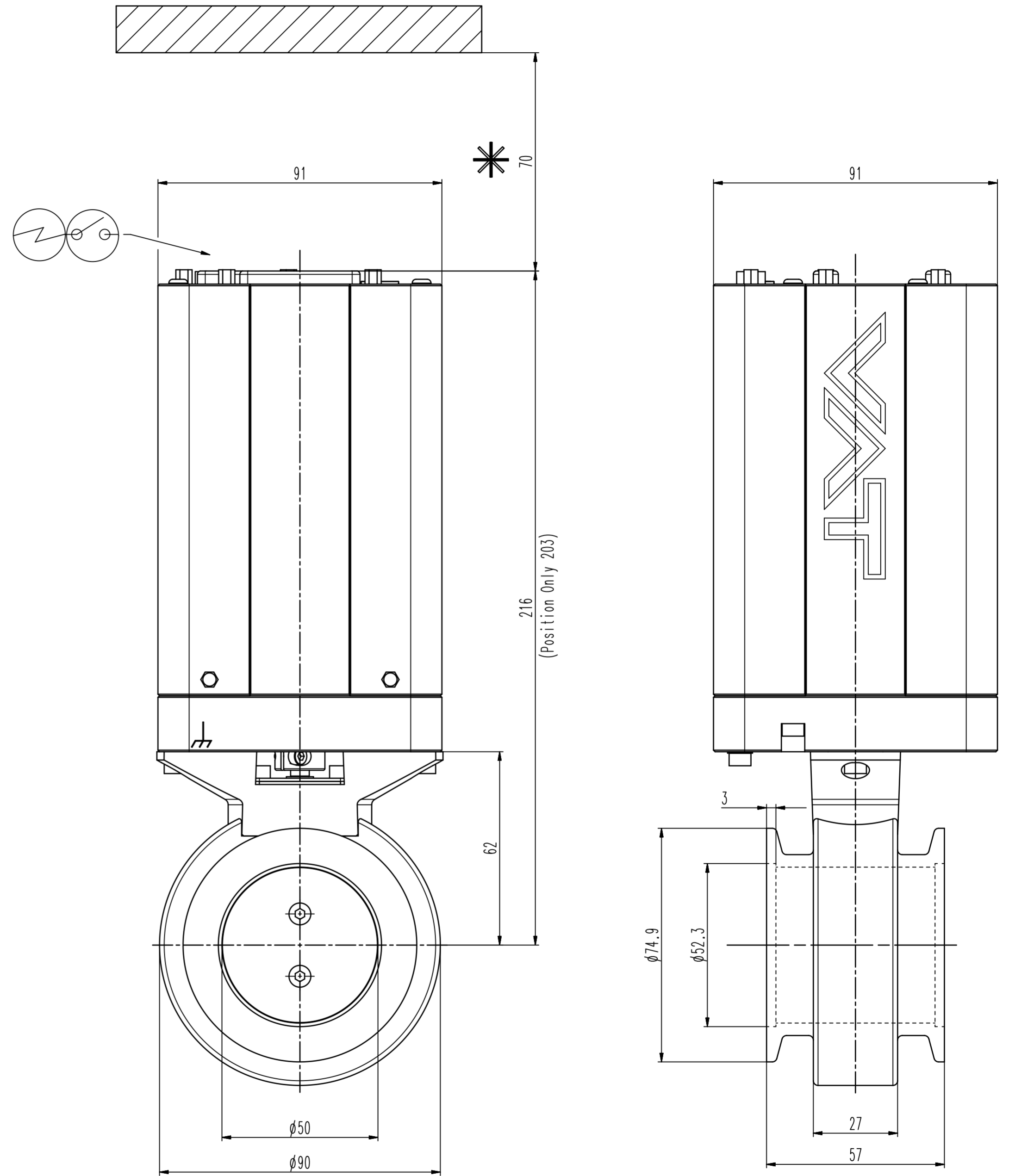
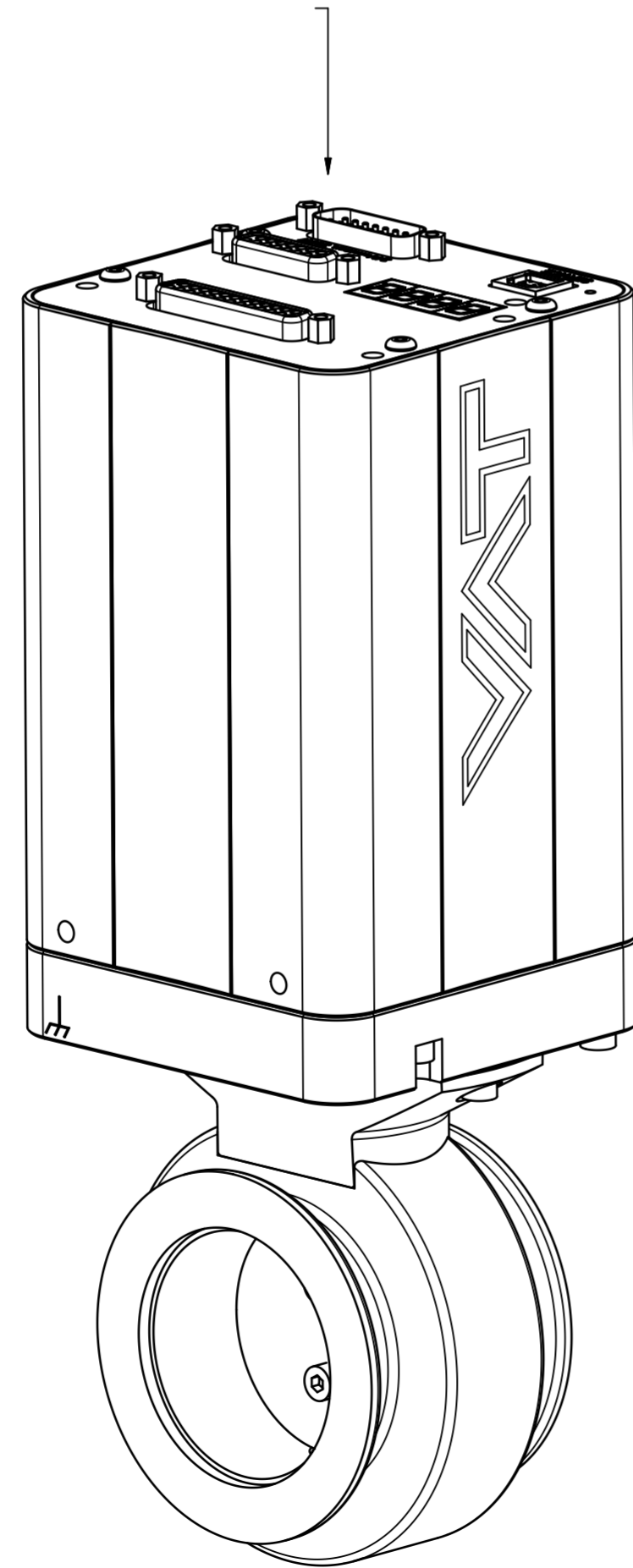

Revision
Customer number

- ▼ Seat side
- ⊕ Comp. air connection
- ⊖ Electrical connection
- ⊗ Leak detection port
- ⊙ Mech. pos. indication
- ⊕ Position indicator
- ⊗ Required for dismantling
- ⊕ Emergency actuation
- ⊖ For attachment
- ⊙ Bake-out area
- ⊗ Differential pumping port

Control butterfly system
generic dimensional drawing for all 613 DN50 valves

VAT VAT Vakuumventile AG
CH-9469 Haag, Switzerland
Tel ++41 81 7716161 Fax ++41 81 7714830

Rev.-Date: 10.06.22
Visa: HUS

Series	613	Ordering No.	-
Projection E	DN	Flange	
	50		
Dimensional Drawing	1166842	Rev.	A